



## Product Catalogue

*Not intended for design layouts; refer to the appropriate "StormTech Design Manual" for specific chamber design information.*

# StormTech Subsurface Stormwater Management

## Table of Contents

Subsurface Stormwater Management.....	2
Specifications and Product Comparison.....	3
BREEAM® Credits.....	4
LEED® Credits.....	5
SC-310 Chamber Specifications.....	6
SC-740 Chamber Specifications.....	8
DC-780 Chamber Specifications.....	10
MC-3500 Chamber Specifications.....	12
MC-4500 Chamber Specifications.....	14
Isolator® Row.....	16
A Family of Products and Services.....	18
Customer Support.....	19

StormTech has well over ten thousand chamber systems in service throughout the world. All StormTech chambers are designed to meet the most stringent industry performance standards for superior structural integrity. The StormTech system is designed primarily to be used under car parks, roadways and heavy earth loads saving valuable land and protecting water resources for commercial and municipal applications. In our continuing desire to answer designers' challenges, StormTech has expanded the family of products providing engineers, developers, regulators and contractors with additional site specific flexibility.

## Advanced Structural Performance for Greater Long-Term Reliability

StormTech developed a state of the art chamber design through:

- Collaboration with world-renowned experts of buried drainage structures to develop and evaluate the structural testing program and product design
- Designing chambers to meet and exceed various European standards for both dynamic and long-term static loads.
- Subjecting the chambers to rigorous full-scale, third party testing, under severe loading conditions to verify their performance both under dynamic loads as well as long term static loads.

## Our Chambers Provide...

- Extremely *efficient transportation*. Stacking of the chambers results in lower cost per m<sup>3</sup> installed volume while being more eco-friendly.

- A *remarkably quick installation*. For example: Ten of the MC-3500 chambers, providing a total installed storage of over 55 m<sup>3</sup>, can be easily installed in 10 minutes. When installing the same 55 m<sup>3</sup> using box type systems you would need to install 125 to 250 boxes, taking significantly more time!
- The *strength* of concrete tanks, but at a very competitive price.
- A robust, *continuous, true elliptical arch design* which effectively transfers loads into the surrounding backfill providing the long-term safety factor required by various local standards. This offers developers a cost-effective underground system that will perform as designed for decades.
- A *design in accordance with various local European design specifications* providing engineers with a structural performance standard for live and long-term dead loads.
- Innovative *polypropylene and polyethylene* resins which have been tested using international standards to ensure long and short-term structural properties.
- Uniform wall thickness and repeatable quality due to *injection mold production*.
- Third party *tested and patented Isolator® Row* for less frequent maintenance, water quality, and long-term performance.
- *Traditional manifold/header designs* using conventional hydraulic equations that can easily verify flow equalization and scour velocity.
- *Open chamber design* requiring only one chamber model to construct each row assuring ease of construction and no repeating end walls to obstruct access or flow.

StormTech offers a variety of chamber sizes (SC-310, SC-740, DC-780, MC-3500 and MC-4500) so the consulting design engineer can choose the chamber that is best suited for the site conditions and regulatory requirements. StormTech has well over ten thousand chamber systems in service worldwide. We provide plan layout and cost estimate services at no charge for consulting engineers and developers.

# StormTech Specifications and Product Comparison



PRODUCT SPECIFICATIONS	SC-310	SC-740	DC-780	MC-3500	MC-4500
Height, mm	405	760	760	1140	1525
Width, mm	865	1295	1295	1955	2540
Length, mm	2300	2300	2300	2285	1320
Installed Length, mm	2170	2170	2170	2185	1230
Bare Chamber Storage, m <sup>3</sup>	0.42	1.30	1.30	3.11	3.01
Stone above, mm	150	150	150	300	300
Foundation Stone, mm*	150	150	230	230	230
Row Spacing, mm	150	150	150	150	230
<b>Minimum Installed Storage, m<sup>3</sup></b>	<b>0.88</b>	<b>2.12</b>	<b>2.22</b>	<b>5.06</b>	<b>4.60</b>
Storage Per Unit Area, m <sup>3</sup>	0.39	0.67	0.70	1.06	1.35

\*Please refer to the design manual.

## Example: Footprint Comparison - 1000m<sup>3</sup> Project

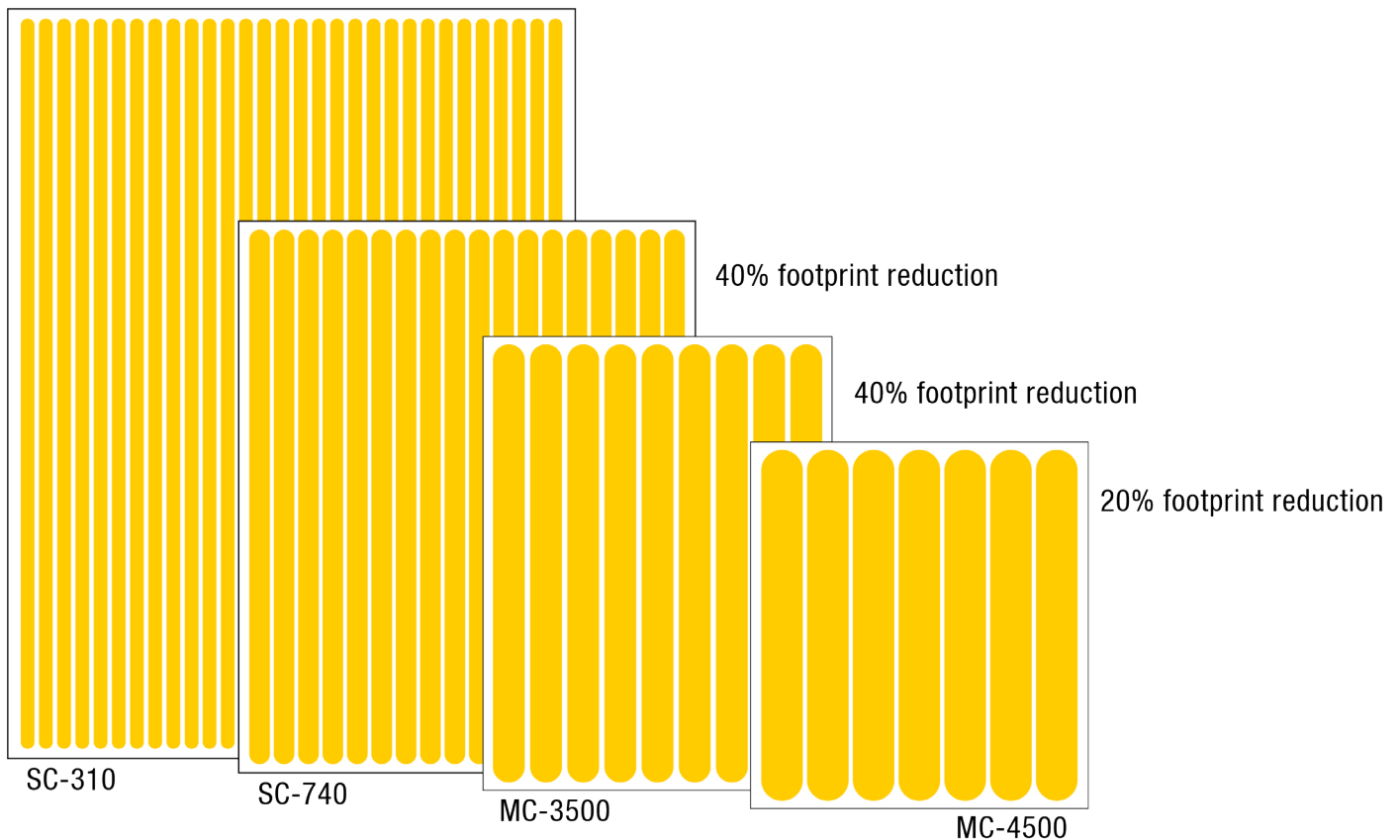

# StormTech BREEAM® Credits

---

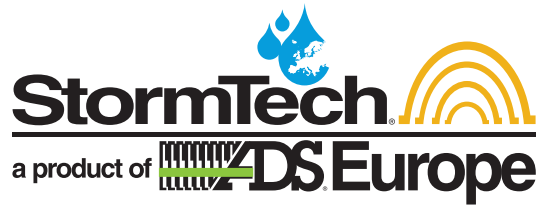

List of BREEAM Credits that StormTech may contribute toward:

## LAND USE AND ECOLOGY

---

- **Credit LE3 Ecological Value of Site and Protection of Ecological Features**  
Utilizing StormTech System beneath roadways, surface parking, walkways, etc. may reduce overall site disturbance.
- **Credit LE4 Mitigating Ecological Impact**  
Utilizing StormTech System beneath roadways, surface parking, walkways, etc. may reduce overall site disturbance.

## WATER

---

- **Credit Wat 5 Water Recycling**  
Utilize StormTech System to store captured rainwater to reduce potable water demand.
- **Credit Wat 6 Irrigation Systems**  
Utilize StormTech System to store captured rainwater for landscape irrigation.

## MATERIALS

---

- **Credit Wst 2 Recycled Aggregates**  
Utilize recycled concrete as the backfill material for the StormTech System.

## POLLUTION

---

- **Credit Pol 5 Flood Risk**  
Utilize StormTech System to reduce the impact of flooding on buildings with a medium-to-high risk of flooding.
- **Credit Pol 6 Minimizing Water Course Pollution**  
Utilize StormTech System to reduce potential for silt, heavy metals, chemicals or oil pollution to natural water-courses from surface water run-off from buildings and hard surfaces.

## INNOVATION

---

- **Credit Inn 1 Innovation**  
Utilize StormTech System to substantially exceed a performance credit.

## MANAGEMENT

---

- **Credit Man 11 Ease of Maintenance**  
Utilize StormTech System to meet this performance credit which is to recognize and encourage the specification of a building and building services that can be easily maintained during their lifecycle.

# StormTech LEED® Credits

---

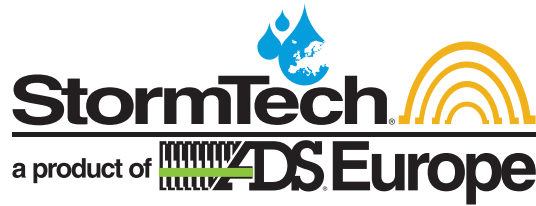

List of LEED Credits that StormTech may contribute toward:

## SUSTAINABLE SITES

---

- **SS Credit 5.1 Site Development: Protect or Restore Habitat**  
Utilizing StormTech System beneath roadways, surface parking, walkways, etc. may reduce overall site disturbance.
- **SS Credit 5.2 Site Development: Maximize Open Space**  
Utilizing StormTech System can increase overall open space and may reduce overall site disturbance.
- **SS Credit 6.1 Stormwater Design: Quantity Control**  
Design StormTech System per local or LEED stormwater quantity requirements, whichever is more stringent.
- **SS Credit 6.2 Stormwater Design: Quality Control**  
Use of Isolator Row provides sediment removal, and can also promote infiltration and groundwater recharge.
- **SS Credit 7.1 Heat Island Effect: Non-Roof**  
Use of StormTech System may eliminate need for above ground detention ponds, thus reducing thermal impacts of stormwater runoff.

## WATER EFFICIENCY

---

- **WE Credit 1 Water Efficient Landscaping**  
Utilize StormTech System to store captured rainwater for landscape irrigation.
- **WE Credit 2 Innovative Water Technologies**  
Utilize StormTech System to store captured rainwater to reduce potable water demand.
- **WE Credit 3 Water Use Reduction**  
Utilize StormTech System to store captured rainwater and allow reuse for non-potable applications.

## MATERIALS

---

- **MR Credit 4 Recycled Content**  
Utilize recycled concrete as the backfill material for the StormTech System.
- **MR Credit 5 Regional Materials**  
Stone backfill material for the StormTech System will apply if extracted within 500 miles of project site.

## INNOVATION & DESIGN

---

- **ID Credit 1 Innovation in Design**  
Utilize StormTech System to substantially exceed a performance credit.

# StormTech SC-310 Chamber Specifications

Designed to meet the most stringent industry performance standards for superior structural integrity while providing designers with a cost-effective method to save valuable land and protect water resources. The StormTech SC-310 system is designed primarily to be used under car parks thus maximizing land usage for commercial and municipal applications.

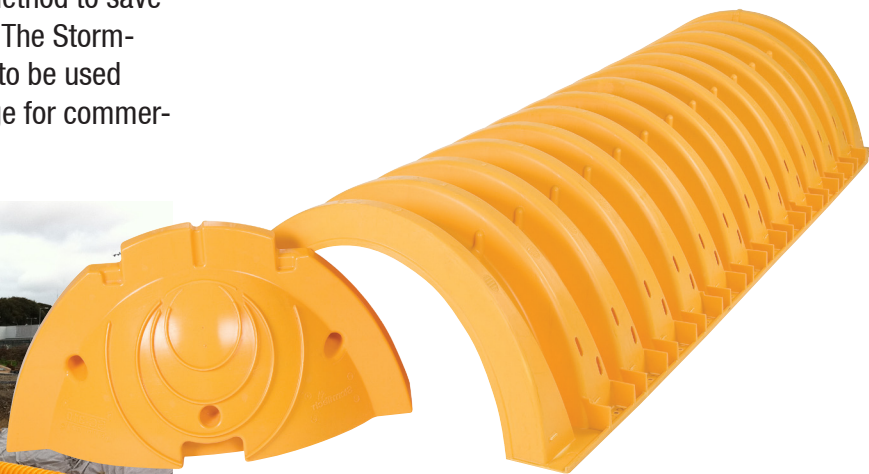

## StormTech SC-310 Chamber (not to scale)

### Nominal Chamber Specifications

Size (L x W x H)	2170 x 865 x 405 mm
Chamber Storage	0.42 m <sup>3</sup>
Min. Installed Storage*	0.88 m <sup>3</sup>
Weight	17.5 kg

\*Assumes 150 mm stone above, below and between chambers and 40% stone porosity.



### Transportation:

656 chambers per truck  
(over 580 m<sup>3</sup> storage per truck)

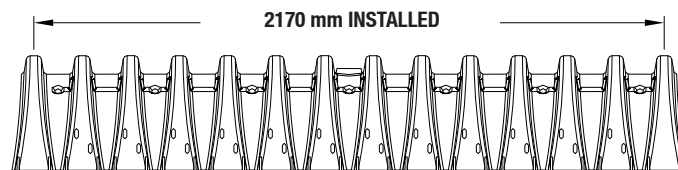
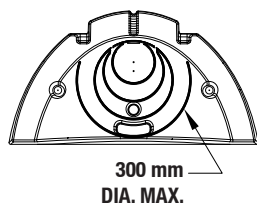
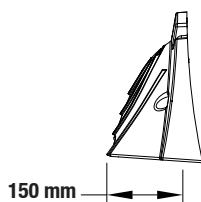
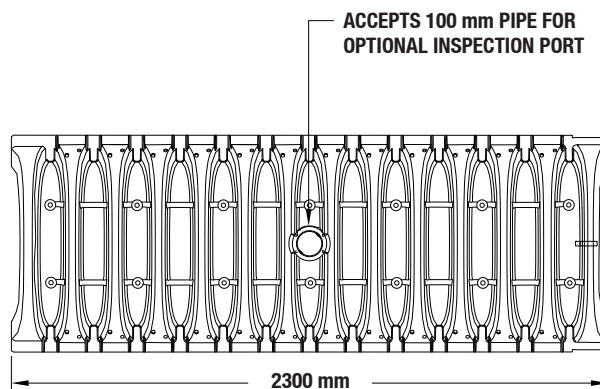
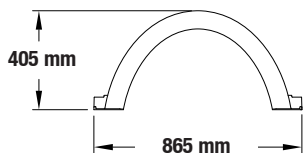

# StormTech SC-310 Chamber Specifications

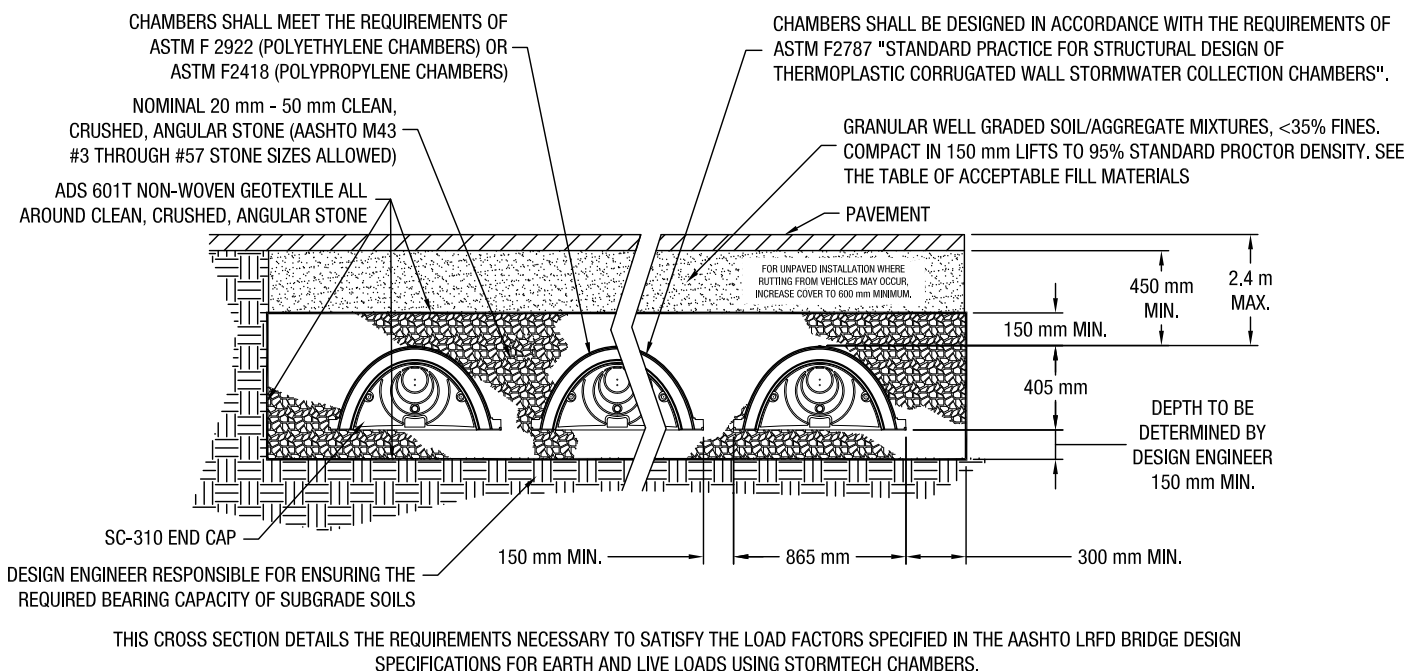

# StormTech SC-740 Chamber Specifications

Designed to meet the most stringent industry performance standards for superior structural integrity while providing designers with a cost-effective method to save valuable land and protect water resources. The StormTech SC-740 system is designed primarily to be used under car parks thus maximizing land usage for commercial and municipal applications.



## StormTech SC-740 Chamber (not to scale)

### Nominal Chamber Specifications

Size (L x W x H)	2170 x 1295 x 760 mm
Chamber Storage	1.30 m <sup>3</sup>
Min. Installed Storage*	2.12 m <sup>3</sup>
Weight	35.5 kg

\*Assumes 150 mm stone above, below and between chambers and 40% stone porosity.

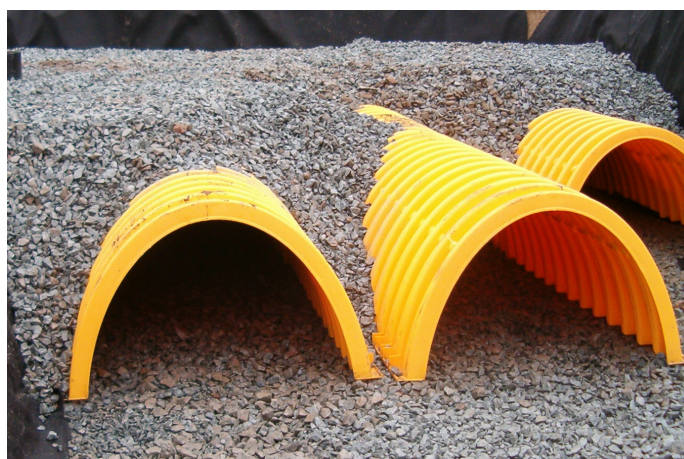

### Transportation:

300 chambers per truck  
(635 m<sup>3</sup> storage per truck)

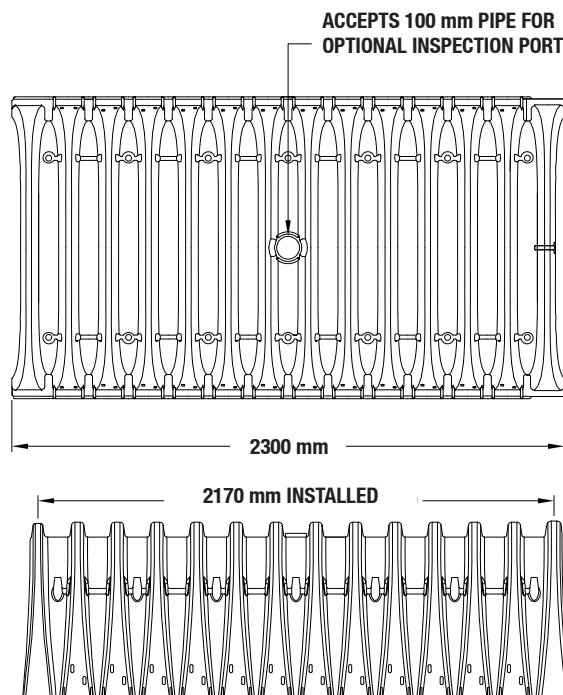
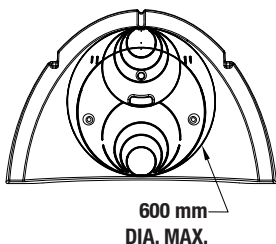
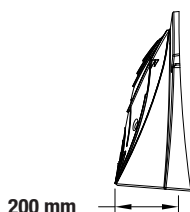
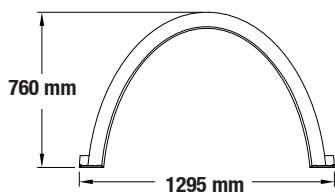



# StormTech SC-740 Chamber Specifications

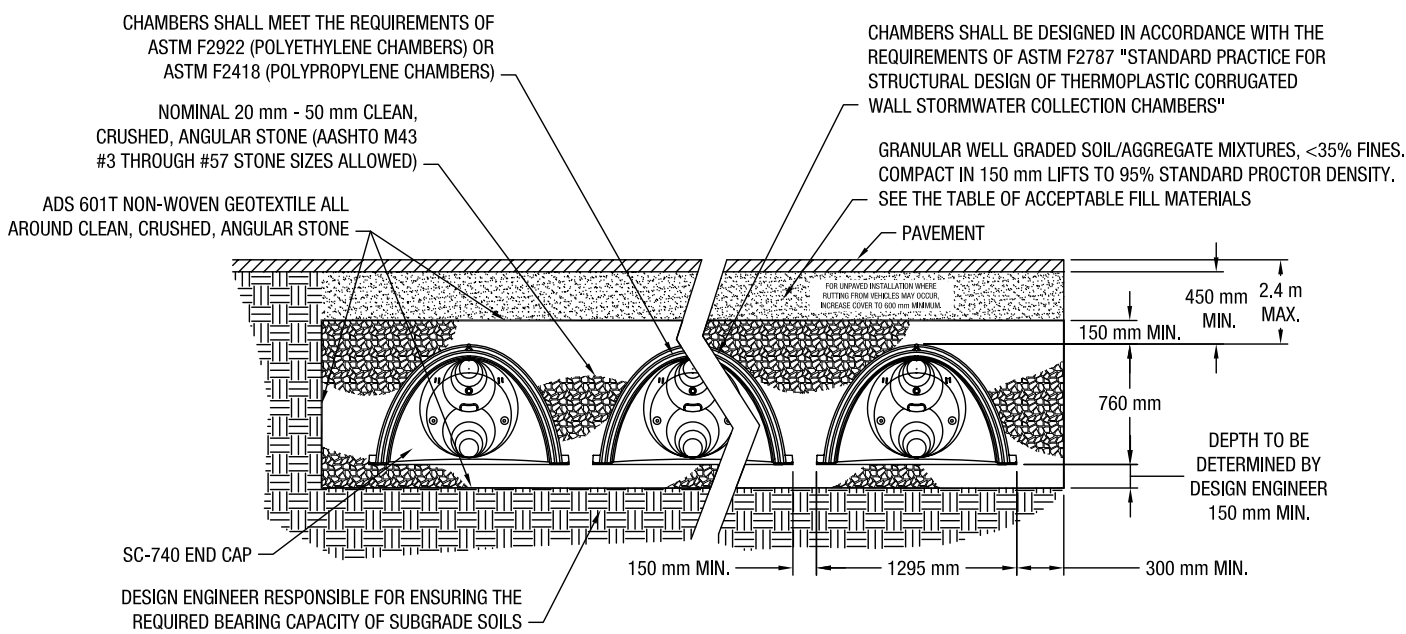

THIS CROSS SECTION DETAILS THE REQUIREMENTS NECESSARY TO SATISFY THE LOAD FACTORS SPECIFIED IN THE AASHTO LRFD BRIDGE DESIGN SPECIFICATIONS SECTION 12.12 FOR EARTH AND LIVE LOADS USING STORMTECH CHAMBERS



# StormTech DC-780 Chamber Specifications

Designed to meet the most stringent industry performance standards for superior structural integrity while providing designers with a cost-effective method to save valuable land and protect water resources. The StormTech DC-780 system is designed specifically to be used for deep cover applications thus maximizing land usage for commercial and municipal applications.

- 3.7 m Deep Cover applications

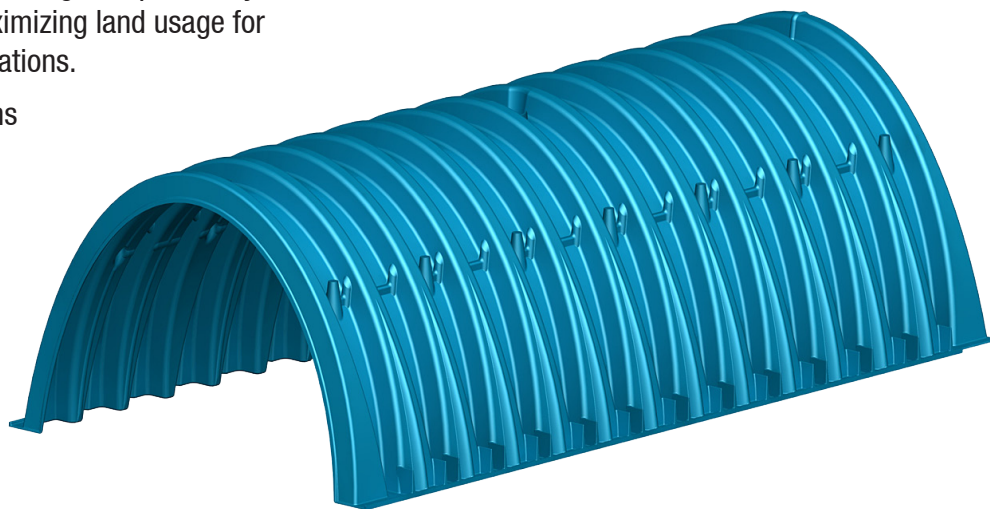

## StormTech DC-780 Chamber (not to scale)

### Nominal Chamber Specifications

Size (L x W x H)	2170 x 1295 x 760 mm
Chamber Storage	1.30 m <sup>3</sup>
Min. Installed Storage*	2.20 m <sup>3</sup>

\*Assumes 230 mm stone below, 150 mm stone above, and 150 mm row-spacing chambers and 40% stone porosity.

### Transportation:

240 chambers per truck  
(530 m<sup>3</sup> storage per truck)

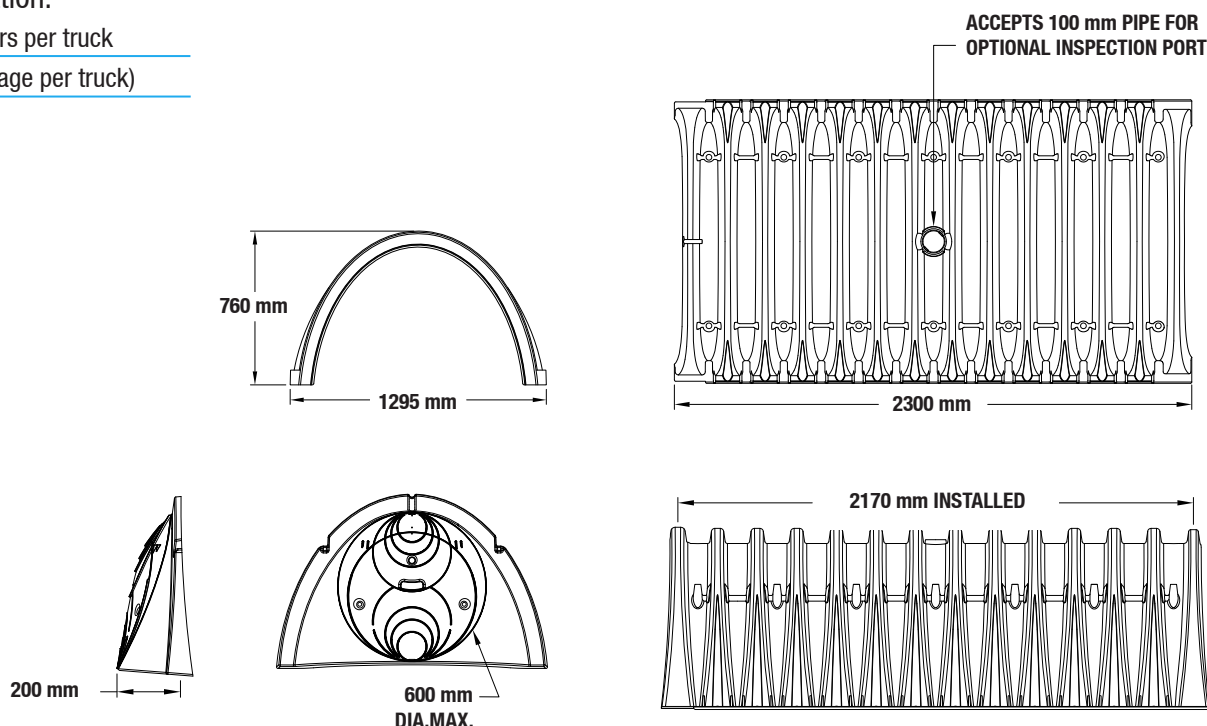

# StormTech DC-780 Chamber Specifications

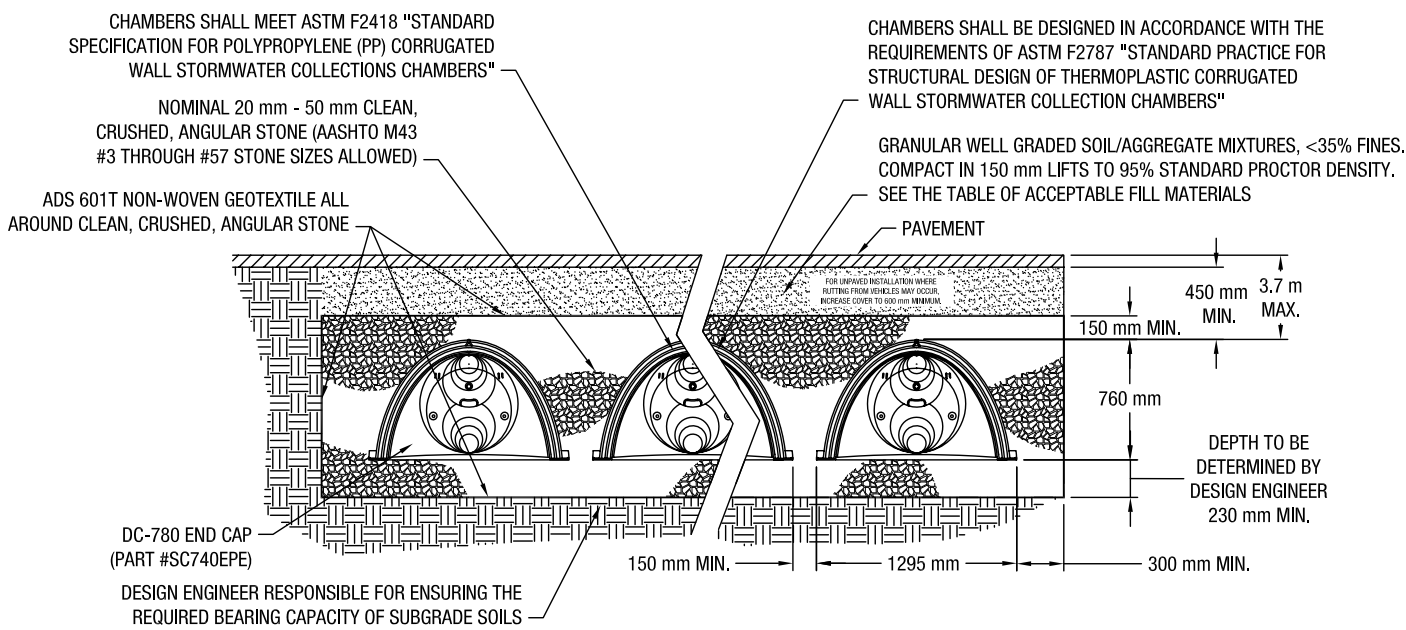

THIS CROSS SECTION DETAILS THE REQUIREMENTS NECESSARY TO SATISFY THE LOAD FACTORS SPECIFIED IN THE AASHTO LRFD BRIDGE DESIGN SPECIFICATIONS SECTION 12.12 FOR EARTH AND LIVE LOADS USING STORMTECH CHAMBERS



# StormTech MC-3500 Chamber Specifications

Designed to meet the most stringent industry performance standards for superior structural integrity while providing designers with a cost-effective method to save valuable land and protect water resources. The StormTech MC-3500 system is designed primarily to be used under car parks thus maximizing land usage for commercial and municipal applications.

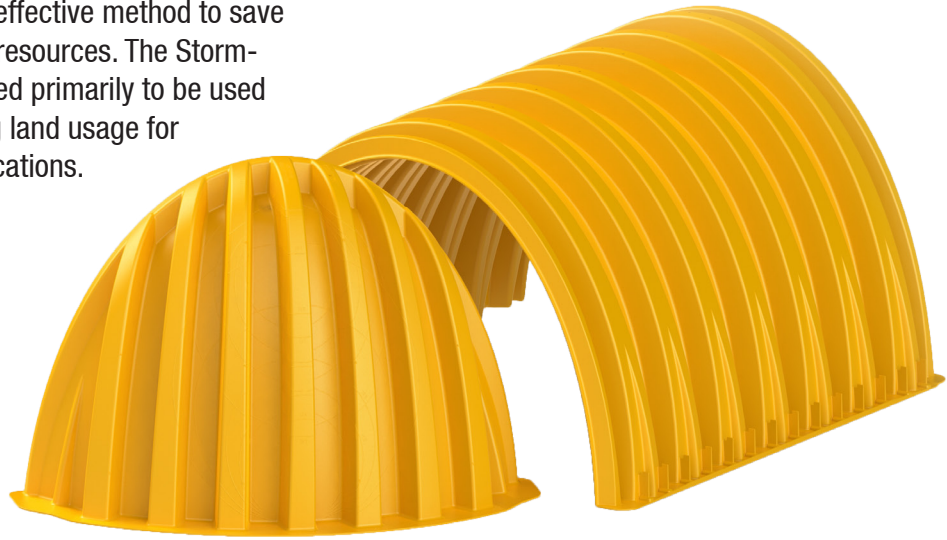

## StormTech MC-3500 Chamber (not to scale)

### Nominal Chamber Specifications

Size (L x W x H)	2285 x 1955 x 1145 mm
Chamber Storage	3.11 m <sup>3</sup>
Min. Installed Storage*	5.06 m <sup>3</sup>
Weight	56.5 kg

\*Assumes a minimum of 305 mm of stone above, 230 mm of stone below, chambers, 230 mm of stone between chambers/end caps, and 40% stone porosity.

## StormTech MC-3500 End Cap (not to scale)

### Nominal End Cap Specifications

Size (L x W x H)	675 x 1805 x 1145 mm
End Cap Storage	0.44 m <sup>3</sup>
Min. Installed Storage*	1.33 m <sup>3</sup>
Weight	19.5 kg

\*Assumes a minimum of 305 mm stone above, 230 mm stone below, 150 mm stone perimeter, 230 mm of stone between chambers/end caps, and 40% stone porosity.

### Transportation:

135 chambers per truck  
(over 685 m<sup>3</sup> storage per truck)

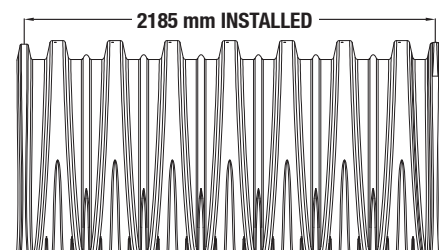
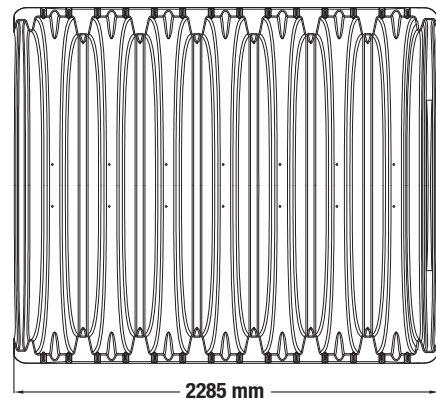
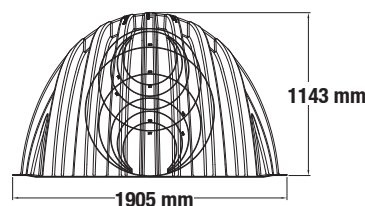
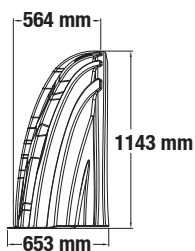
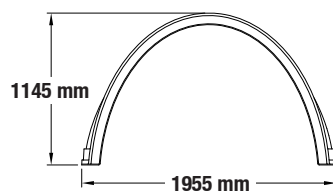

# StormTech MC-3500 Chamber Specifications

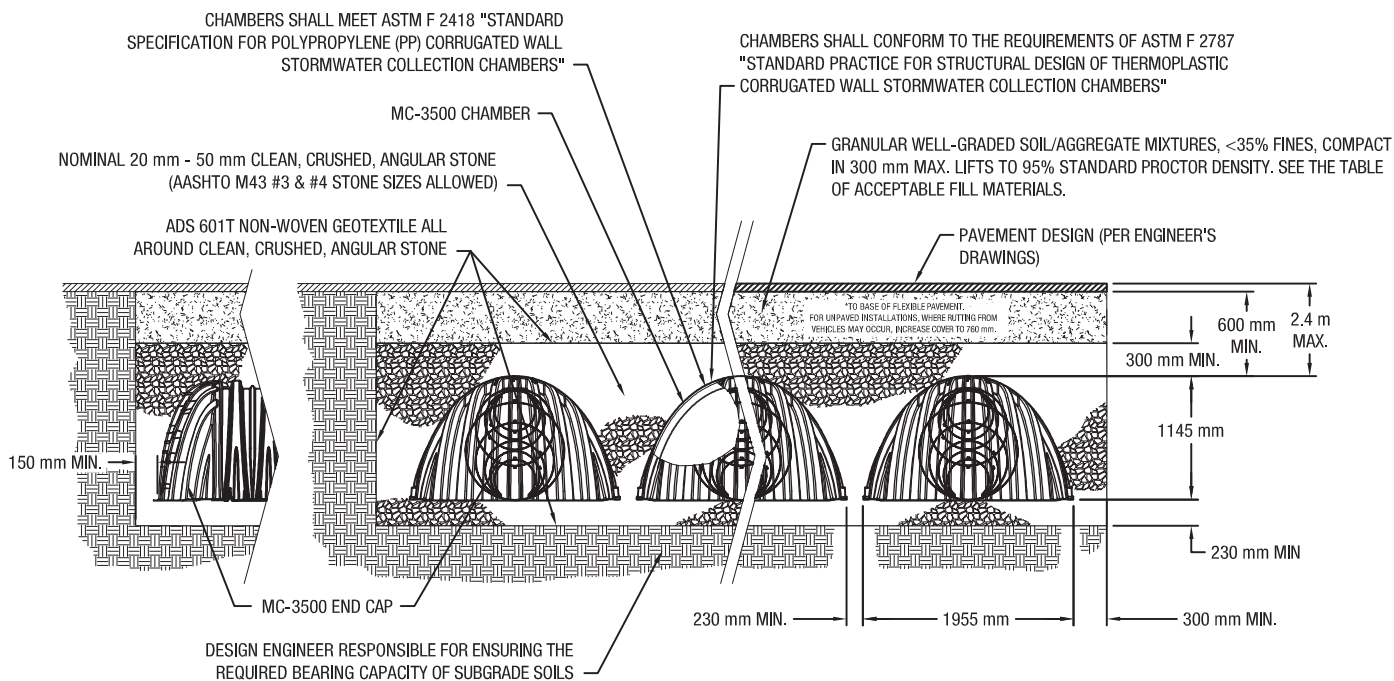

# StormTech MC-4500 Chamber Specifications

Designed to meet the most stringent industry performance standards for superior structural integrity while providing designers with a cost-effective method to save valuable land and protect water resources. The StormTech MC-4500 system is designed primarily to be used under car parks thus maximizing land usage for commercial and municipal applications.

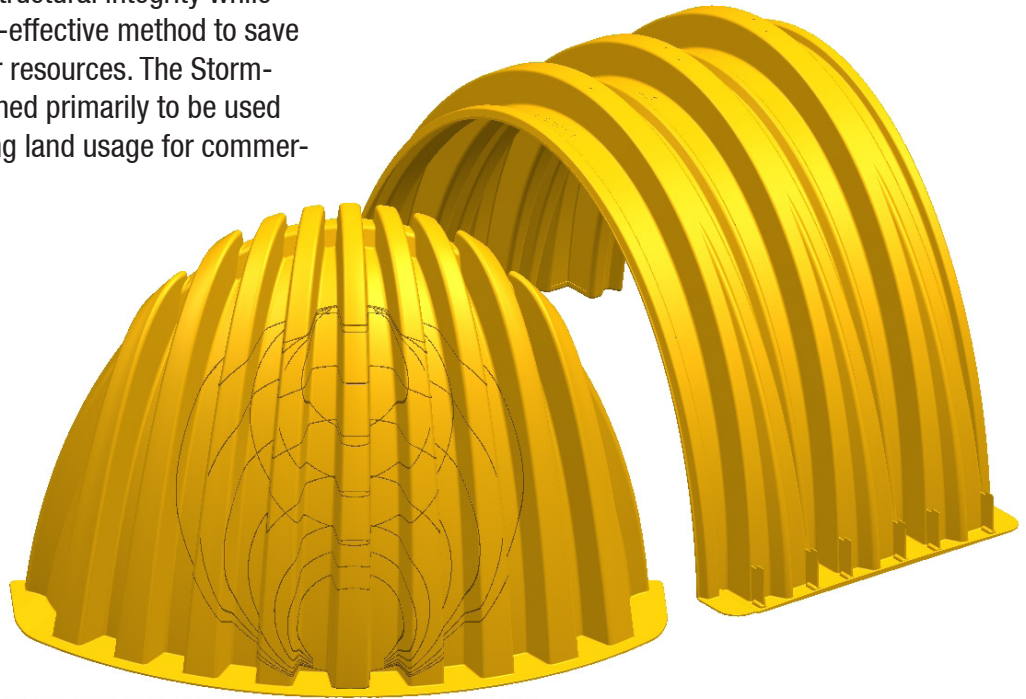

## StormTech MC-4500 Chamber (not to scale)

### Nominal Chamber Specifications

Size (L x W x H)	1320 x 2540 x 1525 mm
Chamber Storage	3.01 m <sup>3</sup>
Min. Installed Storage*	4.60 m <sup>3</sup>
Nominal Weight	53.5 kg

\*Assumes a minimum of 300 mm of stone above, 230 mm of stone below chambers, 230 mm of stone between chambers/end caps, and 40% stone porosity.

## StormTech MC-4500 End Cap (not to scale)

### Nominal End Cap Specifications

Size (L x W x H)	890 x 2290 x 1510 mm
End Cap Storage	1.01 m <sup>3</sup>
Min. Installed Storage*	3.08 m <sup>3</sup>
Nominal Weight	53.5 kg

\*Assumes a minimum of 300 mm of stone above, 230 mm of stone below, 305 mm of stone perimeter, 230 mm of stone between chambers/end caps, and 40% stone porosity.

### Transportation:

84 chambers per truck  
(over 385 m<sup>3</sup> storage per truck)

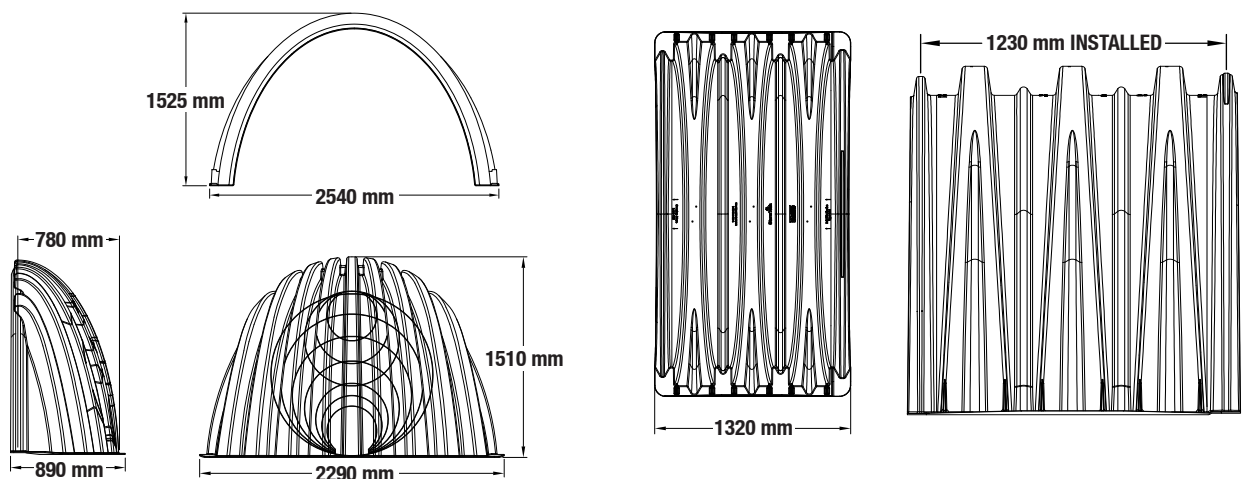

# StormTech MC-4500 Chamber Specifications



CHAMBERS SHALL MEET ASTM F2418 "STANDARD SPECIFICATION FOR POLYPROPYLENE (PP) CORRUGATED WALL STORMWATER COLLECTION CHAMBERS."

NOMINAL 20 mm - 50 mm CLEAN, CRUSHED, ANGULAR STONE (AASHTO M43 #3 & #4 STONE SIZES ALLOWED)

ADS 601T NON-WOVEN GEOTEXTILE ALL AROUND CLEAN, CRUSHED, ANGULAR STONE

CHAMBERS SHALL BE DESIGNED IN ACCORDANCE WITH ASTM F2787 "STANDARD PRACTICE FOR STRUCTURAL DESIGN OF THERMOPLASTIC CORRUGATED WALL STORMWATER COLLECTION CHAMBERS."

GRANULAR WELL-GRADED SOIL/AGGREGATE MIXTURES, <35% FINES, COMPACT IN 300 mm MAX. LIFTS TO 95% STANDARD PROCTOR DENSITY. SEE THE TABLE OF ACCEPTABLE FILL MATERIALS.

PAVEMENT DESIGN (PER ENGINEER'S DRAWINGS)

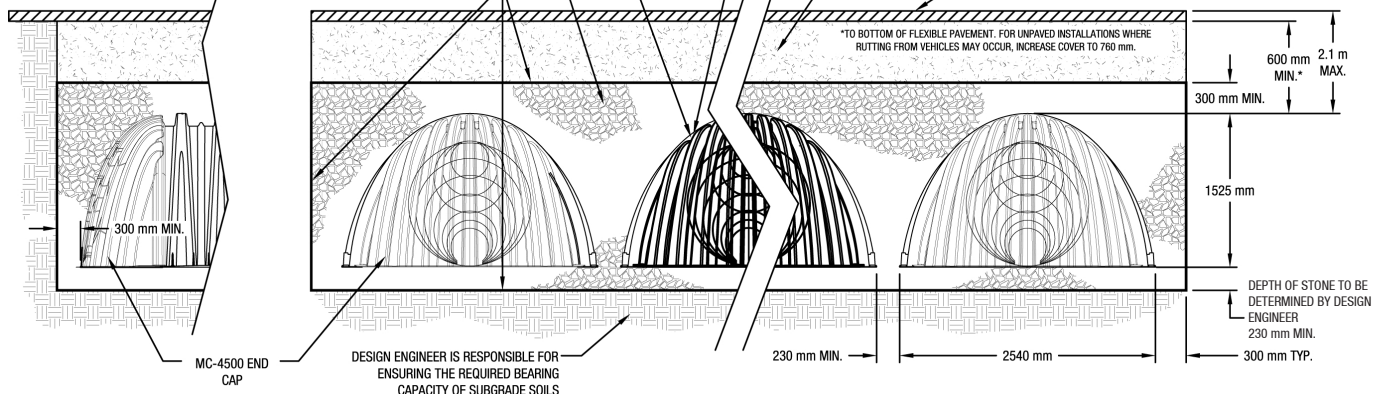

THE INSTALLED CHAMBER SYSTEM SHALL PROVIDE THE LOAD FACTORS SPECIFIED IN THE AASHTO LRFD BRIDGE DESIGN SPECIFICATIONS SECTION 12.12 FOR EARTH AND LIVE LOADS, WITH CONSIDERATION FOR IMPACT AND MULTIPLE VEHICLE PRESENCES.



# StormTech Isolator<sup>®</sup> Row



An important component of any Stormwater Pollution Prevention Plan is inspection and maintenance. The StormTech Isolator Row is a patented technique to inexpensively improve stormwater quality and provide easy access for inspection and maintenance. By using the StormTech Isolator Row a TSS removal of 80%, a hydrocarbon (diesel) removal of 90%, a total Zinc removal of 53% and a total Phosphorus removal of 49% can be achieved.\*

The Isolator Row is a row of StormTech chambers that is surrounded with filter fabric and connected to a closely located manhole for easy access. The fabric-wrapped chambers provide for settling and filtration of sediment as stormwater rises in the Isolator Row and ultimately passes through the filter fabric. The open bottom chambers and perforated sidewalls (SC-310 and SC-740 models) allow stormwater to flow both vertically and horizontally out of the chambers. Sediments are captured in the Isolator Row, protecting the storage areas of the adjacent stone and chambers from sediment accumulation.

Two different fabrics are used for the Isolator Row. A woven geotextile fabric is placed between the stone and the Isolator Row chambers. The tough geotextile provides a media for stormwater filtration and provides a durable surface for maintenance operations. It is also designed to prevent scour of the underlying stone and remain intact during high pressure jetting. A non-woven fabric is placed over the chambers to provide a filter media for flows passing through the perforations in the sidewall of the chamber. The non-woven fabric is not required over the DC-780, MC-3500 or MC-4500 models as these chambers do not have perforated side walls.

The Isolator Row is typically designed to capture the “first flush” and offers the versatility to be sized on a volume basis or flow rate basis. An upstream manhole not only provides access to the Isolator Row, but typically includes a high flow weir such that stormwater flow rates or volumes that exceed the capacity of the Isolator Row crest the weir and discharge through a manifold to the other chambers.

The Isolator Row may also be part of a treatment train. By treating stormwater prior to entry into the chamber system, the service life can be extended and pollutants such as hydrocarbons can be captured. Pre-treatment best management practices can be as simple as deep sump catch basins and oil-water separators or can be innovative storm water treatment devices. The design of the treatment train and selection of pretreatment devices by the design engineer is often driven by regulatory requirements. Whether pretreatment is used or not, the Isolator Row is recommended by StormTech as an effective means to minimize maintenance requirements and maintenance costs.

Note: See the StormTech Design Manual for detailed information on designing inlets for a StormTech system, including the Isolator Row.

\*Based on independent university testing.

## StormTech Isolator Row with Overflow Spillway (not to scale)

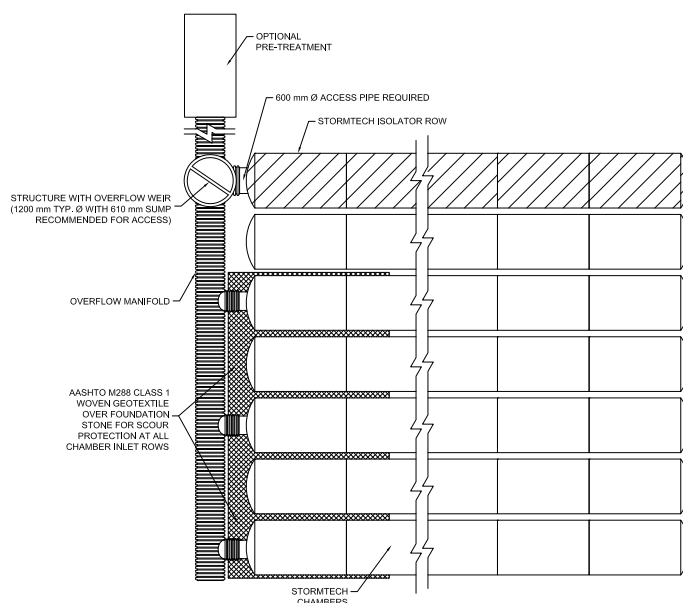



# StormTech Isolator Row

## Inspection

The frequency of Inspection and Maintenance varies by location. A routine inspection schedule needs to be established for each individual location based upon site specific variables. The type of land use (i.e. industrial, commercial, residential), anticipated pollutant load, percent imperviousness, climate, etc. all play a critical role in determining the actual frequency of inspection and maintenance practices.

At a minimum, StormTech recommends annual inspections. Initially, the Isolator Row should be inspected every 6 months for the first year of operation. For subsequent years, the inspection should be adjusted based upon previous observation of sediment deposition.

The Isolator Row incorporates a combination of standard manhole(s) and strategically located inspection ports (as needed). The inspection ports allow for easy access to the system from the surface, eliminating the need to perform a confined space entry for inspection purposes.

If, upon visual inspection it is found that sediment has accumulated, a stadia rod should be inserted to determine the depth of sediment. When the average depth of sediment exceeds 8 cm throughout the length of the Isolator Row, clean-out should be performed.

## Maintenance

The Isolator Row was designed to reduce the cost of periodic maintenance. By “isolating” sediments to just one row, costs are dramatically reduced by eliminating the need to clean out each row of the entire storage bed. If inspection indicates the potential need for maintenance, access is provided via a manhole(s) located on the end(s)

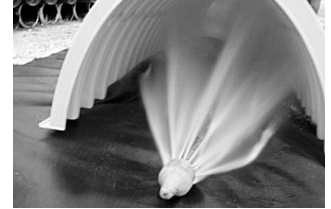

of the row for cleanout. If entry into the manhole is required, please follow the applicable rules and regulations for a confined space entries.

Maintenance is accomplished by jetting the Isolator Row. The jetting process utilizes a high pressure water nozzle to propel itself down the Isolator Row while scouring and suspending sediments. As the nozzle is retrieved, the captured pollutants are flushed back into the manhole for vacuuming. Most sewer and pipe maintenance companies have vacuum/jetting combination vehicles. Selection of an appropriate jetting nozzle will improve maintenance efficiency. Fixed nozzles designed for culverts or large diameter pipe cleaning are preferable. Rear facing jets with an effective spread of at least 45° are best. Most jetting reels have 120 meters of hose allowing maintenance of an Isolator Row up to 50 chambers long. **The jetting process shall only be performed on StormTech Isolator Rows that have the correct woven geotextile (as specified by StormTech) over their angular base stone.**

## StormTech Isolator Row (not to scale)

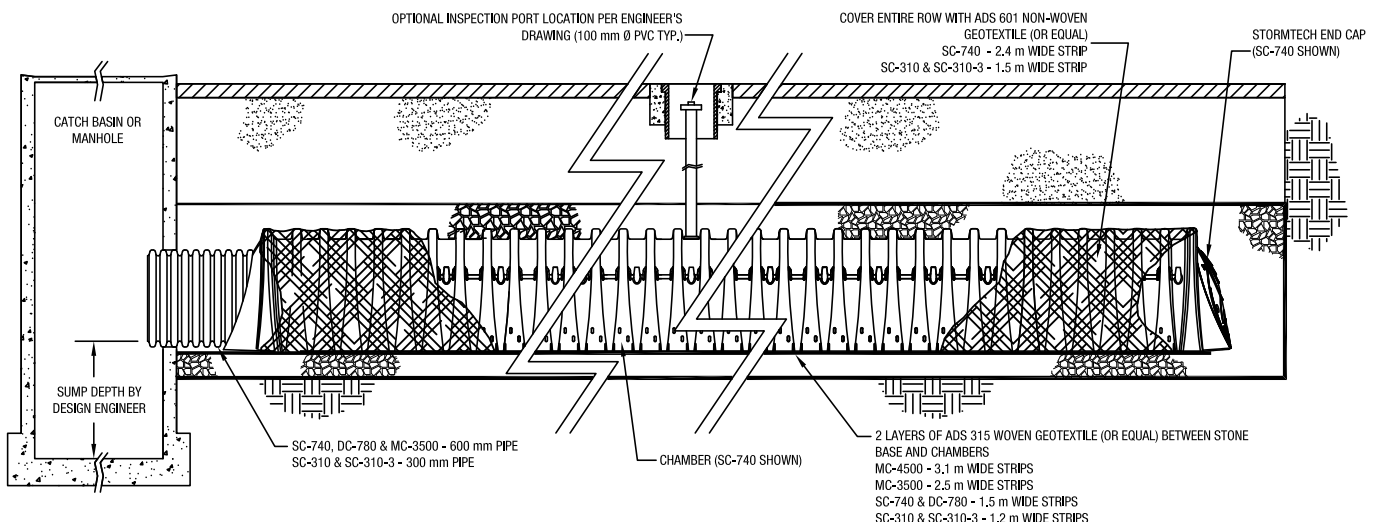

NOTE: NON-WOVEN FABRIC IS ONLY REQUIRED OVER THE INLET PIPE CONNECTION INTO THE END CAP FOR DC-780, MC-3500 AND MC-4500 CHAMBER MODELS AND IS NOT REQUIRED OVER THE ENTIRE ISOLATOR ROW.

# A Family of Products and Services

- SC-310 Chambers and End Caps
- SC-740 Chambers and End Caps
- DC-780 Chambers and End Caps
- MC-3500 Chambers and End Caps
- MC-4500 Chambers and End Caps
- SC, DC and MC Fabricated End Caps
- Fabricated Manifold Fittings
- Patented Isolator Row for Maintenance and Water Quality
- In-House System Layout Assistance
- On-Site Educational Seminars
- Worldwide Technical Sales Group
- Centralized Product Applications Department
- Research and Development Team
- Technical Literature, O&M Manuals and Detailed CAD drawings all downloadable via our website at [www.stormtech.com/international](http://www.stormtech.com/international)

***"Interested in using StormTech products in your design? We would be glad to help you. StormTech provides plan layout and cost estimate services at no additional charge for consulting engineers and developers."***

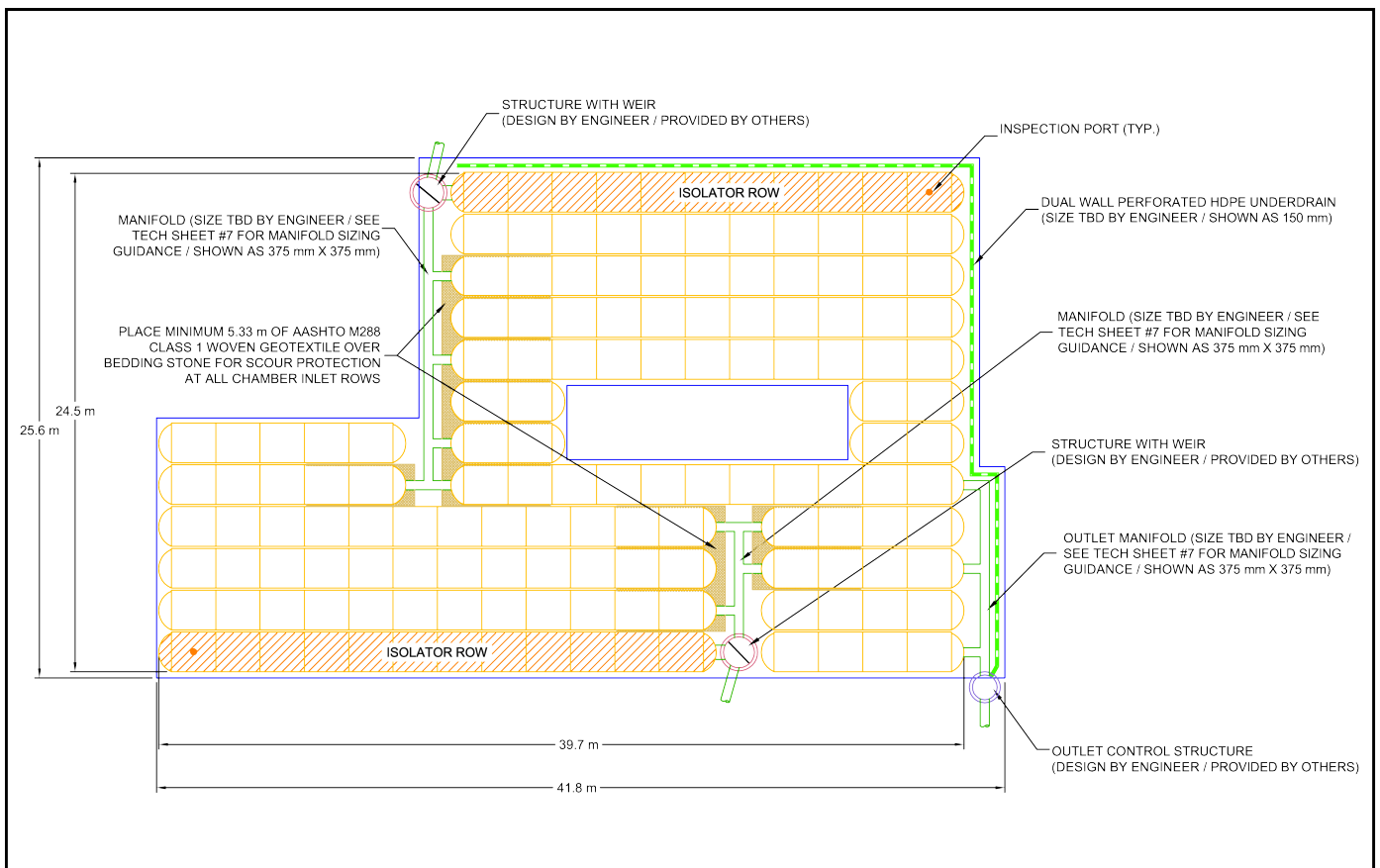

DATE	DRAWN	CHECKED	DESCRIPTION	PROPOSED STORMTECH MC-3500 PLAN LAYOUT		
				DATE:	06-27-12	PROJECT:
				DRAWN:	KAM	SCALE:
				CHECKED:	KS	PAGE:
						1 OF 1



THIS DRAWING HAS BEEN PREPARED BASED ON INFORMATION PROVIDED TO STORMTECH UNDER THE DIRECTION OF THE DESIGN ENGINEER OR OTHER PROJECT REPRESENTATIVE. THE DESIGN ENGINEER SHALL REVIEW THIS DRAWING PRIOR TO CONSTRUCTION. IT IS THE ULTIMATE RESPONSIBILITY OF THE DESIGN ENGINEER TO ENSURE THAT THE PRODUCT(S) DEPICTED AND ALL ASSOCIATED DETAILS MEET ALL APPLICABLE LAWS, REGULATIONS, AND PROJECT REQUIREMENTS.



MARCO POLOSTRAAT 2-14  
3165 AL ROTTERDAM  
THE NETHERLANDS  
T: +31 (0)10-299-6310  
WWW.STORMTECH.COM/INTERNATIONAL

# StormTech Customer Support



Please contact one of our inside Technical Service professionals or Engineered Product Managers (EPMs) to discuss your particular application. A wide variety of technical support material is available from our website at [www.stormtech.com/international](http://www.stormtech.com/international). For any questions, please call StormTech at **+31 (0)10 2996410**.

- SC-310, SC-740, and DC-780 Design Manual
- MC-3500 and MC-4500 Design Manual
- SC-310, SC740, and DC-780 Installation Instructions
- MC-3500 and MC-4500 Installation Videos
- Infiltrator Row Informational Video
- CAD Drawings
- Technical Sheets
- Site Calculator Spreadsheets
- Installation Guidelines and Industry Standards
- Industry Links
- Free Layout Assistance
- Pre-construction Meetings
- Case Studies



# StormTech



  
**StormTech**  
a product of  **ADS Europe**

Marco Polostraat 2-14 | 3165 AL | Rotterdam | The Netherlands  
+31 (0) 10-299-6410

[www.stormtech.com/international](http://www.stormtech.com/international)

ADS "Terms and Conditions of Sale" are available on the ADS website, [www.ads-pipe.com](http://www.ads-pipe.com).  
Advanced Drainage Systems, the ADS logo, and the green stripe are registered trademarks of Advanced Drainage Systems.  
StormTech® and the Isolator® Row are registered trademarks of StormTech, Inc.  
USGBC and the USGBC Member logo are registered trademarks of U.S. Green Building Council.

